

Quick Installation Guide

PoE Extender

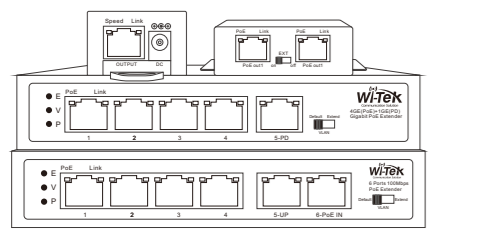

WI-PE31E | WI-PE51E | WI-PE31G | WI-PE51G | WI-PE21E | WI-PE21G

1. Packing Content

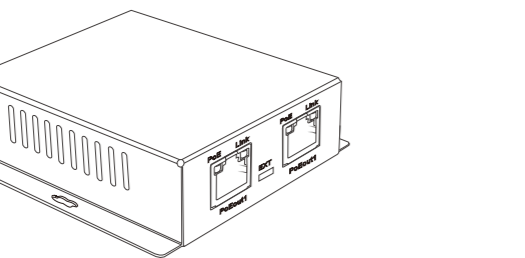

1 x PoE Extender

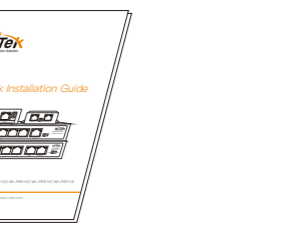

1 x Quick Installation Guide

2. Appearance Overview

- WI-PE31E

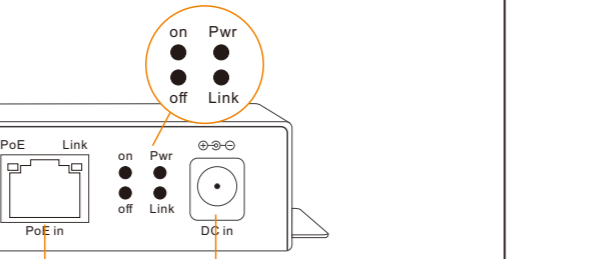

1*100Mbps PoE+ Input DC Input 37-57V

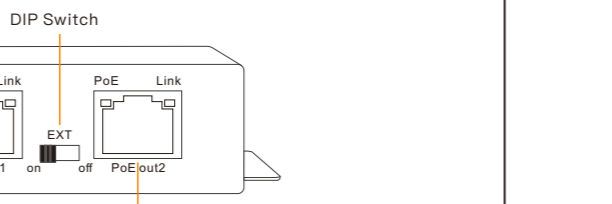

2*1000Mbps PoE+ Output

WI-PE31E DIP Switch Description	
Extend	On: The transmission of PoE output ports can be up to 250m, but the rate is limited to 10Mbps Off: The transmission of PoE output ports can be up to 100m with 100Mbps (WI-PE31G transmission rate can reach 1000Mbps)

LED Indicators	
PWR (Power indicator)	Off: the device is power off or failed On: the device power on is normal
Link Indicator	On: ports link up Off: ports link down Blinking: data on TX/RX
PoE Indicator	Off: PoE not working On: PoE working

- WIPE31G

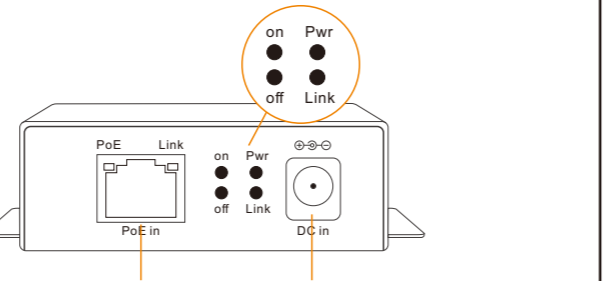

1*1000Mbps PoE+ Input DC Input 37-57V

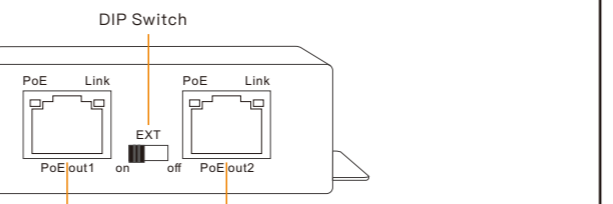

2*1000Mbps PoE+ Output

WI-PE31G DIP Switch Description	
Extend	On: The transmission of PoE output ports can be up to 250m, but the rate is limited to 10Mbps Off: The transmission of PoE output ports can be up to 100m with 100Mbps (WI-PE31G transmission rate can reach 1000Mbps)

LED Indicators	
PWR (Power indicator)	Off: the device is power off or failed On: the device power on is normal
Link Indicator	On: ports link up Off: ports link down Blinking: data on TX/RX
PoE Indicator	Off: PoE not working On: PoE working

- WI-PE51G

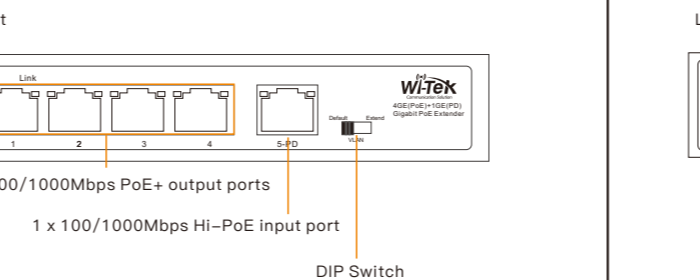

4 x 100/1000Mbps PoE+ output ports
1 x 100/1000Mbps Hi-PoE input port
DIP Switch

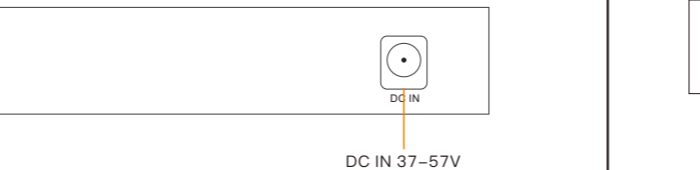

LED Indicators	
P	Off: the device is power off or failed On: the device power on is normal
Link Indicator	Off: ports link down On: ports link up Blinking: data on TX/RX
PoE Indicator	Off: PoE not working On: PoE working
V	Off: VLAN mode is disable. On: VLAN mode is enable.
E	Off: Extend mode is disable On: Extend mode is enable

- WI-P51E

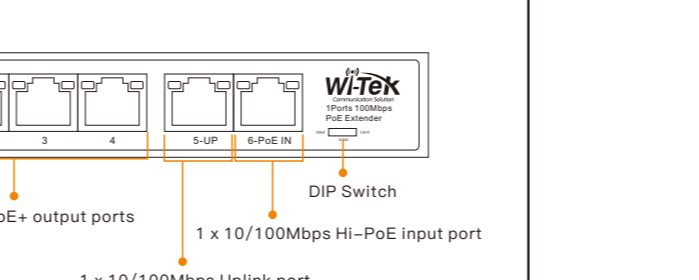

4 x 10/100Mbps PoE+ output ports
1 x 10/100Mbps Hi-PoE input port
DIP Switch



LED Indicators	
P	Off: the device is power off or failed On: the device power on is normal
Link Indicator	Off: ports link down On: ports link up Blinking: data on TX/RX
PoE Indicator	Off: PoE not working On: PoE working
V	Off: VLAN mode is disable. On: VLAN mode is enable.
E	Off: Extend mode is disable On: Extend mode is enable

- WI-PE21G



1 x 100/1000Mbps PoE+ output port
DC 37-57V



1 x 100/1000Mbps PoE+ input port

LED Indicators	
Speed	On: The negotiate speed is 1000Mbps Off: The negotiate speed is 10/100Mbps
Link	On: ports link up Off: ports link down Blinking: data on TX/RX

- WI-PE21E

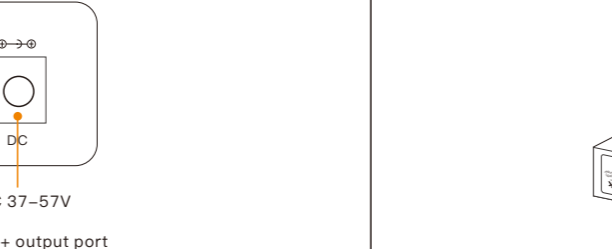

1 x 100/1000Mbps PoE+ output port
DC 37-57V



1 x 10/100Mbps PoE+ input port

LED Indicators	
Speed	On: The negotiate speed is 10/100Mbps Off: Ports link down
Link	On: ports link up Off: ports link down Blinking: data on TX/RX

3. Installation

- Desktop Installation

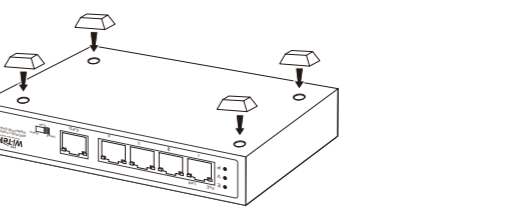

- Wall-mount Installation

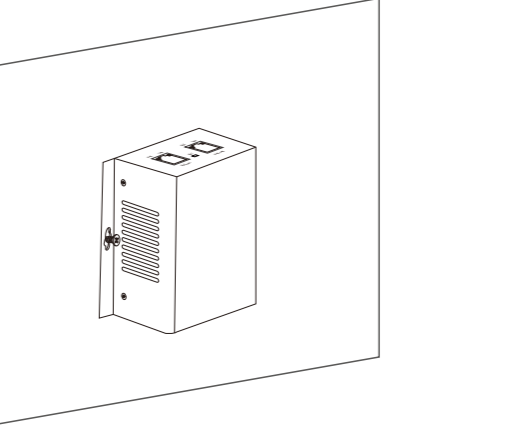

4. Network Application

- Networking Solution (illustration for WI-PE31E)

- Step 1: Connect the first PoE extender to the PoE port of switch which is compatible with 802.3af/at/bt. (Or connect a DC adapter to power up the first PoE extender)
- Step 2: Connect the second PoE extender to the first PoE extender via PoE input port.
- Step 3: Connect an IP camera to the second PoE extender via PoE output port.

Note: Recommend no more than 4 units PoE extender in one network.

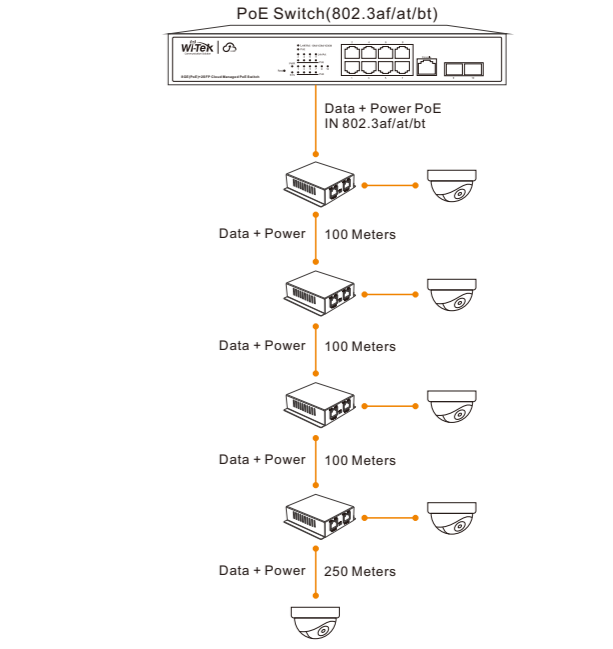

Warranty Card

Username	
Address	
Telephone No.	
Purchase Shop	
Purchase Address	
Product Model No.	
Purchase Time	
Serial No.	
Dealer Signature	

- * If the product defects within three months after purchase, we will provide you a new product of the same model.
- * If the product defects within the three-year warranty period, we will provide the professional maintenance service.
- * Proof of purchase and a complete product serial number are required to receive any services guaranteed as part of the limited warranty.
- * Any other defects that are not caused by workmanship or product quality, such as natural disaster, water damage, extreme thermal or environmental conditions, sticker damaged, warranty card losing will disqualify the product from limited warranty.



Wireless-Tek Technology Limited
Address: Biaofang Technology Building 402, Bao'an street, Baoan District, Shenzhen City, Guangdong, China
Website: www.wireless-tek.com
Tel: 86-0755-32811290
Email: sales@wireless-tek.com
Technical Support: tech@wireless-tek.com

